

PRODUCT SPECIFICATION

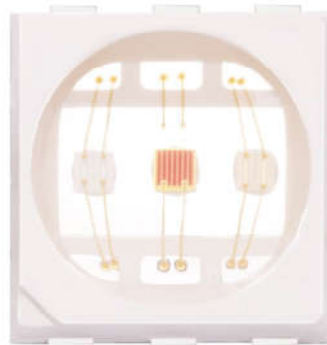

Part No. : JH-5054GRB12J31-T11A-Y
High Power LED

Catalog

1.Product Features	P2
2.Dimensions	P2
3.Absolute Maximum Rating	P3
4.Optical Character	P3
5.Optical Character Curves	P4
6.Spectrum Curves	P5
7.Viewing Angle Curves	P5
8.Tape&Reel Packing	P6
9.Soldering Advice	P7
10.Cautions	P8

1.Product Features

- High Brightness GRB LED
- Round Package
- Viewing Angle 120 Degree
- Chip Material: IngaN AlGaInP
- RoHS Compliant

2.Dimensions

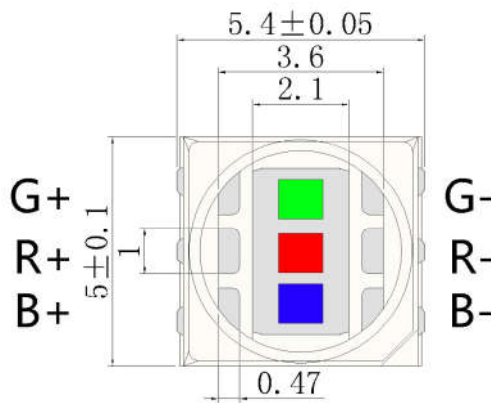

Top view

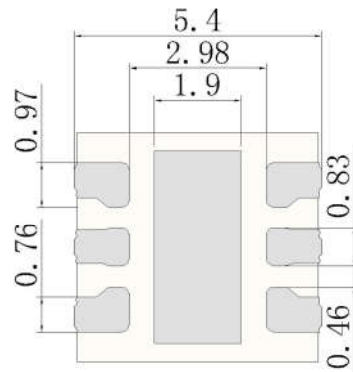

Bottom view

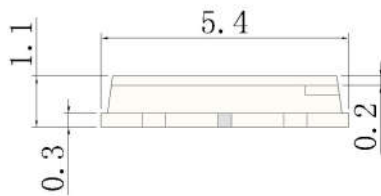

Side view

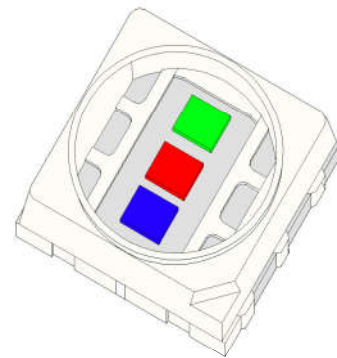

Perspective view

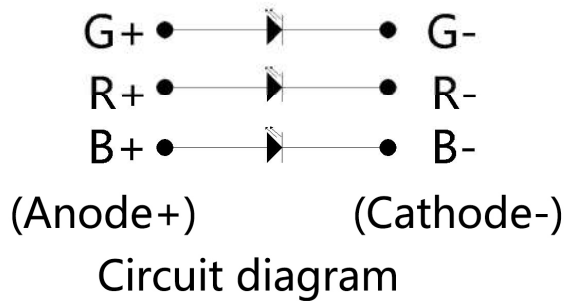

Notes:

1. All dimensions are in millimeters.
2. Tolerance is $\pm 0.1\text{mm}$ unless otherwise noted.

3. Absolute Maximum Rating @ Ta=25° C

Parameter	Symbol	Maximum Rating	Unit
Continuous Forward Current	IF	350	mA
Peak Forward Current (1/10 Duty Cycle, 0.1ms Pulse Width)	IFp	500	mA
Reverse Voltage	VR	5	V
Power Dissipation	PD	500	mW
Electrostatic Discharge	ESD	1000	V
Operating Temperature Range	TOPR	-25°C to +60°C	
Storage Temperature Range	TSTG	-35°C to +80°C	
Lead Soldering Temperature	TSOL	260°C	

4. 光学特征 @ Ta=25°C / Optical Character @ Ta=25° C

Parameter	Symbol	Color	Min.	Typ.	Max.	Unit	Test Condition
Forward Voltage	VF	G	2.8	3.0	3.2	V	IF=350mA
		R	2.0	2.2	2.4	V	IF=350mA
		B	3.0	3.2	3.4	V	IF=350mA
Luminous Flux	Φ	G	70	80	90	Lm	IF=350mA
		R	30	35	40	Lm	IF=350mA
		B	10	15	20	Lm	IF=350mA
Dominant Wavelength	Wld	G	520	522.5	525	nm	IF=350mA
		R	620	622.5	625	nm	IF=350mA
		B	460	462.5	465	nm	IF=350mA
Reverse Current	IR				10	μA	VR=5V
Viewing Angle	2θ1/2				120	deg	IF=350mA
Recommend Forward Current	IF(rec)	GRB			350	mA	

Notes:

Measurement tolerance of forward voltage±0.1V

5. Optical Character Curves

(25 ° Ambient Temperature Unless Otherwise Noted)

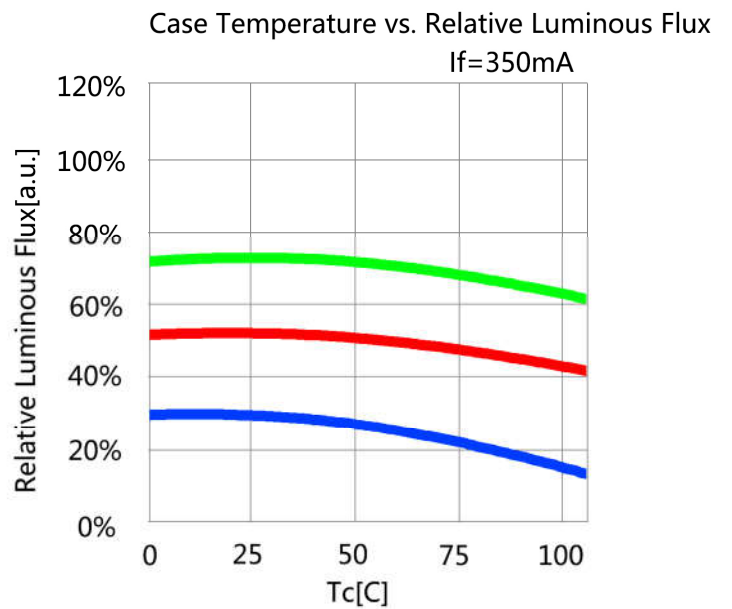
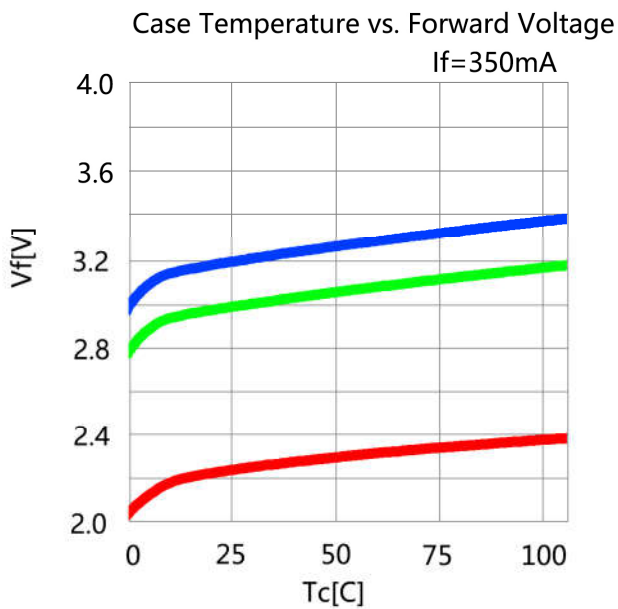
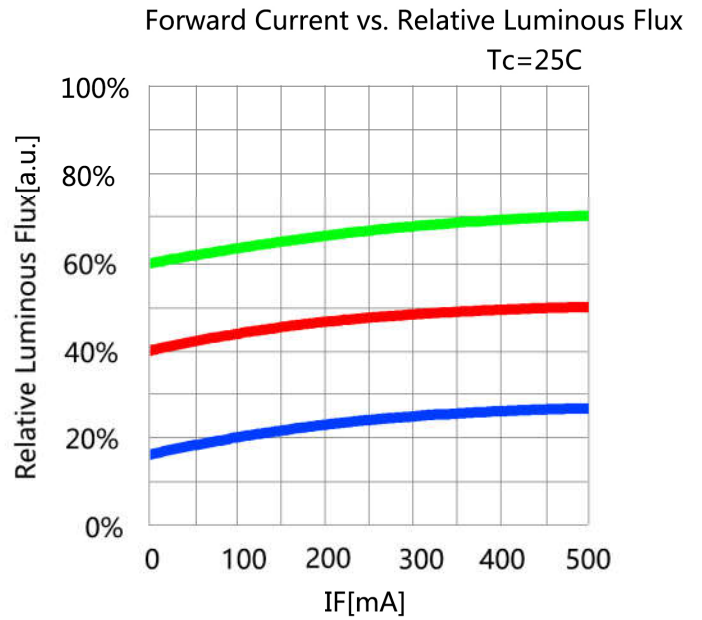
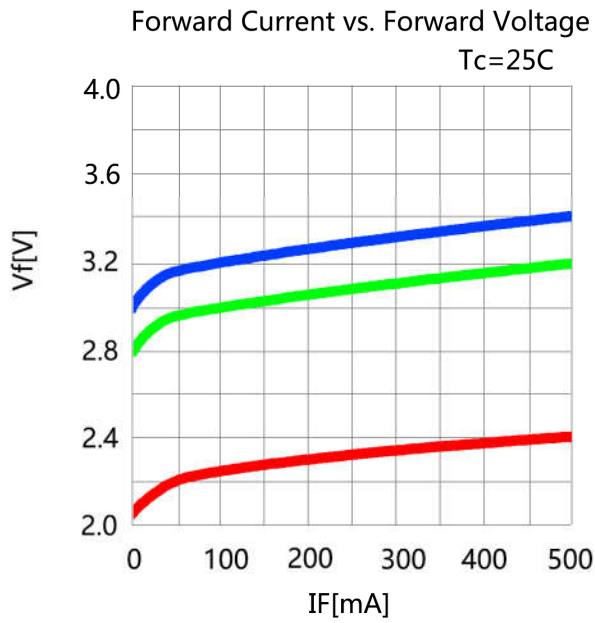

6. Spectrum Curves

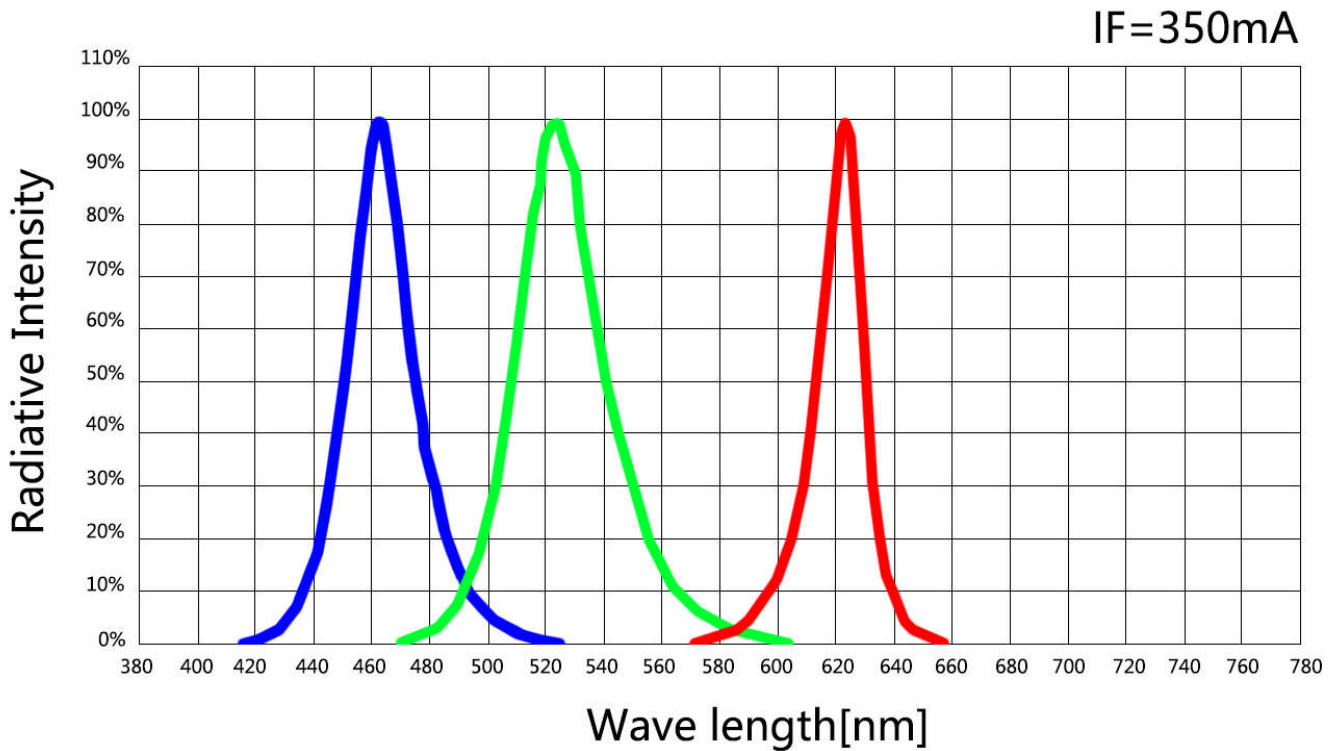

7. Viewing Angle Curves

Radiation Characteristic

IF=350mA

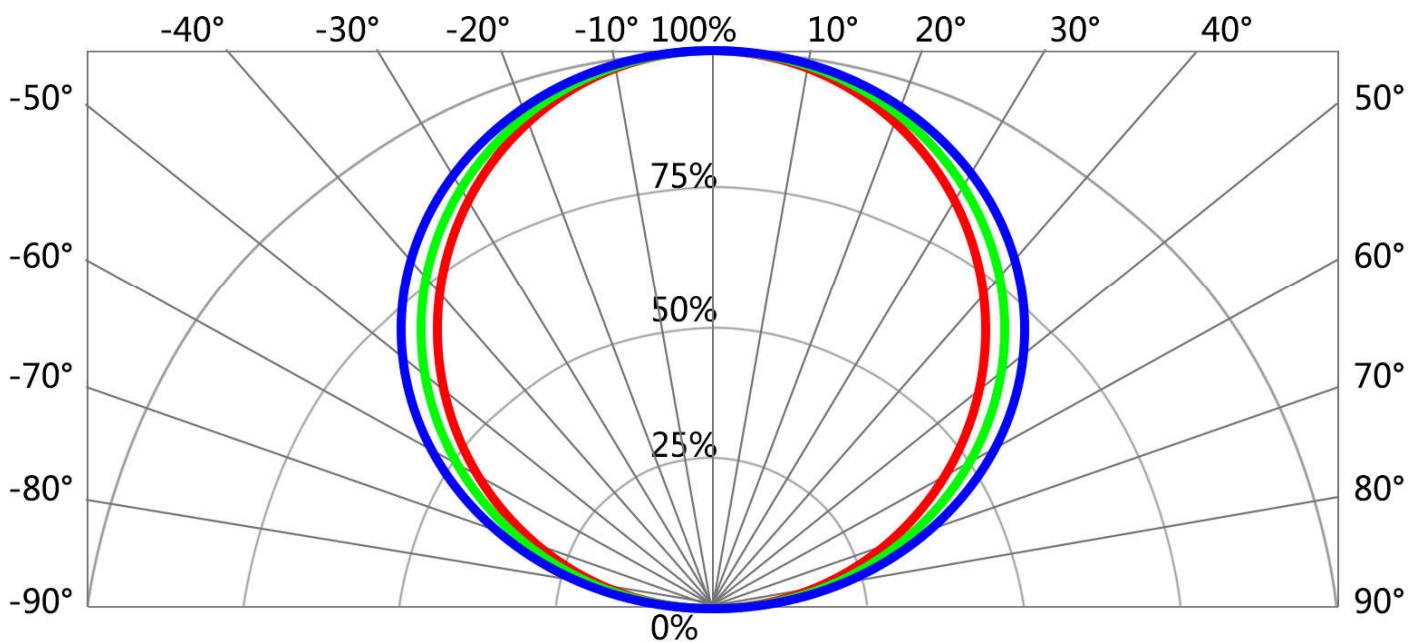

8. Tape & Reel Packing

1. Recommend unpacked LED beads be welded within one day, if not, please vacuumize again and store in an environment of 20-35°C and 30-60% humidity. If can't vacuumize, please store LED beads in moisture proof box, control at 25°C ± 3°C, humidity 50-60%. If unpacked above 1 week, bake at 60 ± 5°C for 10-12 hours before weld.

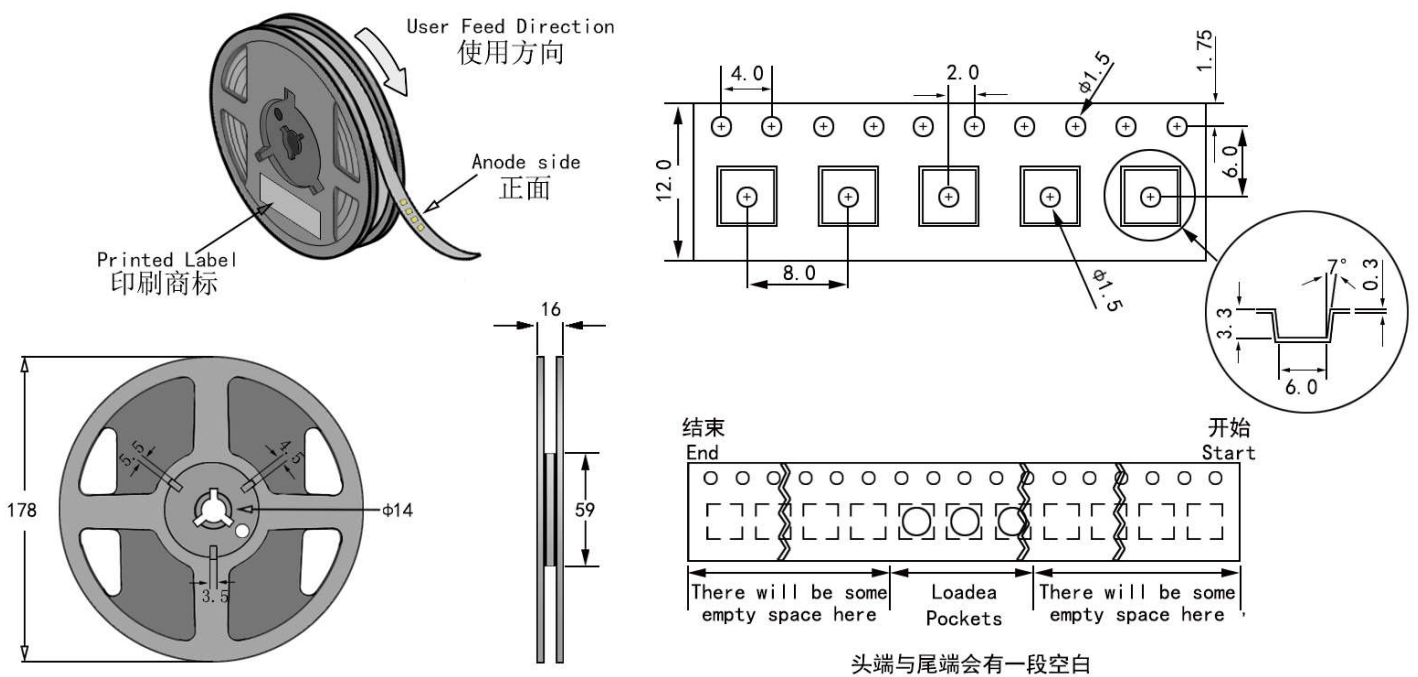

Notes:

1. QTY: 1000pcs/Reel
2. Tolerance $\pm 0.2\text{mm}$.
3. Package: P/N

9.Soldering Advice

1. When soldering, don't touch the LED appearance gel during, this bad operation will destroy the LED. Moding LED usually use reflow soldering, please refer to the following reflow temperature curve , and recommend the user follow the soldering temperature curve of the solder paste.

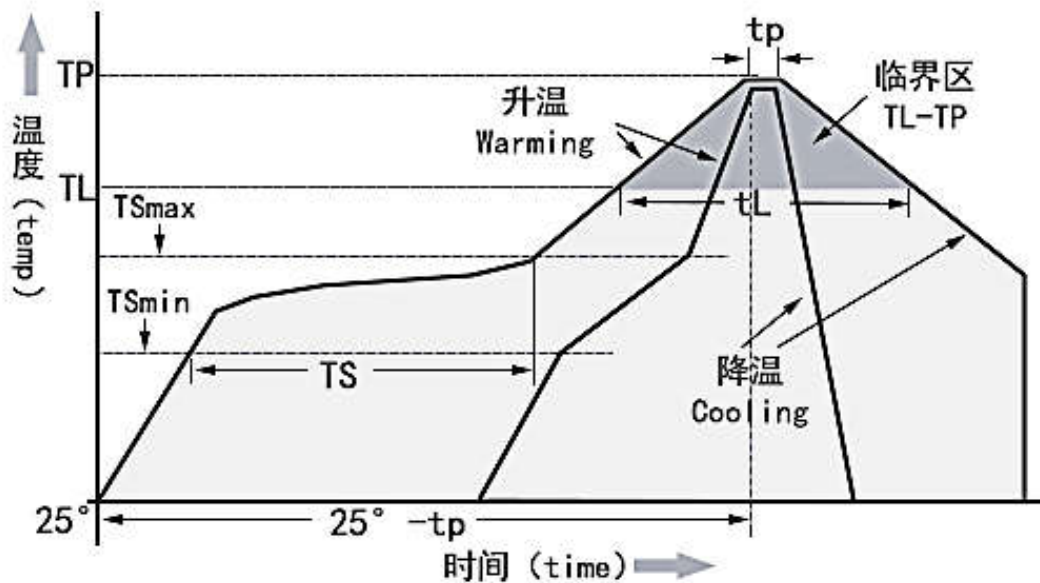

Temperature Curve Character	Lead-free solder
Average heating rate(TSmin to Tp)	最高 3°C/秒 Top 3 °C / s
Preheating: Minimum temperature (TSmin)	90°C
Preheating: Maximum temperature (TSmax)	200°C
Preheating: Time (TSmin to TSmax)	60-180 s
Duration above temperature: Temperature TL	240°C
Duration above temperature: Time tL	60-150 s
Peak/classification temperature (Tp)	260°C
Time within 5°C of actual peak temperature (tp)	20-40 s
Cooling speed	最高 6°C/秒 The highest 6 °C / s
Time to reach peak temperature at 25°C	最多 8 分钟 8 minutes Max

10. Cautions

1. Electrostatic Treatment

Do a full range of anti-static measures (such as: anti-static ring, anti-static clothes, machine, equipment grounding wire, etc.)



2. Heat Dissipation

- A、 It is recommend to configure reasonable heat dissipation device for the product.
- B、 The best working temperature range of the product is 40-60°. It is recommended to control the working temperature of the product within a reasonable range.

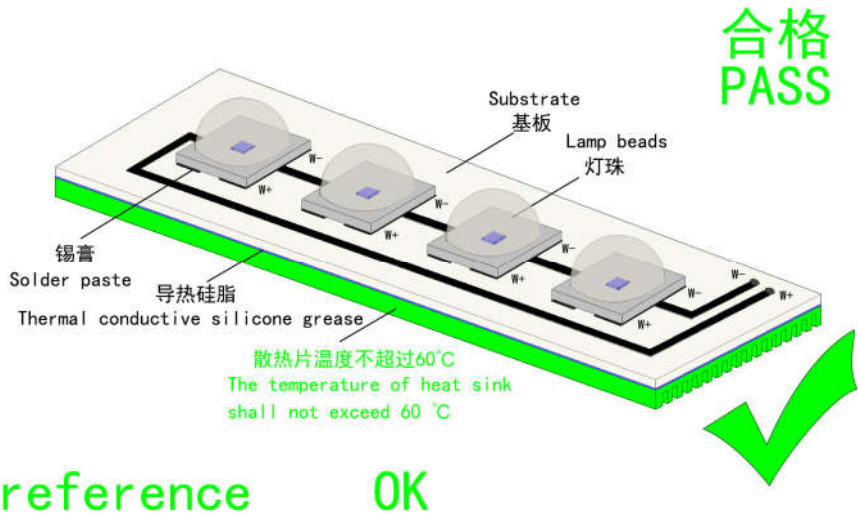

3. Installation Conditions

- A、 Do not exert any pressure on the LED area during the use of the led beads.such as below:

